

Type MR - 3 Watt (Obsolete - for reference only - substitute Type LW) Wirewound Controls



Power Rating: 3 Watts @ 55°C
Derate linearly to 0 @ 105°C

Ohms Tolerance: ±20% (Standard)
(Other tolerances available)

Dielectric Strength: Mounting plate to terminals,
high pot test for 1 minute
@ 900 VAC

Stop Strength: 12 inch pounds (Minimum)

Operating Torque: 1/2 - 10 inch ounces

Resistance Taper: Linear only

Mechanical Rotation: 240

Electrical Rotation: 215

Contact Arm: Insulated from case.

PC Mount - No Snap

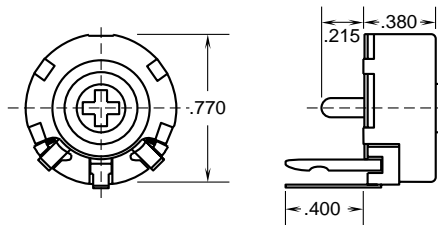

Ohms Rating	Max Amperes	Catalog Number
15	.450	MR15P
100	.170	MR100P
600	.071	MR600P
1K	.055	MR1000P
1.5K	.045	MR1500P
3K	.032	MR3000P
5K	.024	MR5000P

Tab Mount

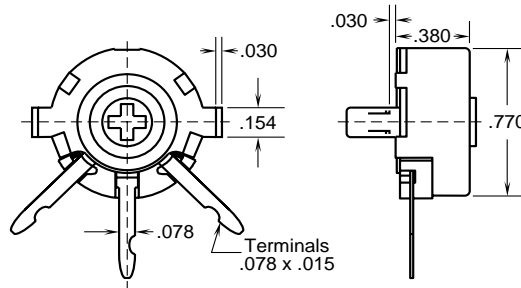

Ohms Rating	Max Amperes	Catalog Number
50	.240	MR50T
10K	.017	MR10KT

.154 Twist Tab, .246 Long
Center-to-center mounting dimension: -.925

Flange Mount

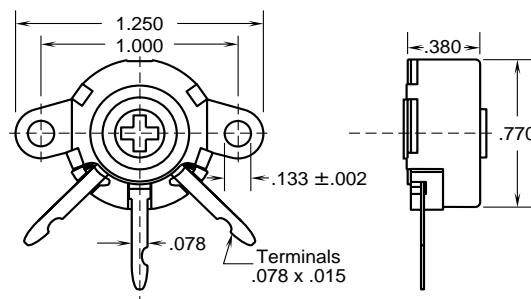

Ohms Rating	Max Amperes	Catalog Number
100	.170	MR100F
500	.077	MR500F
1K	.055	MR1000F
2.5K	.035	MR2500F

Mounting ear holes - .130 Dia. on 1" centers

Bushing Mount

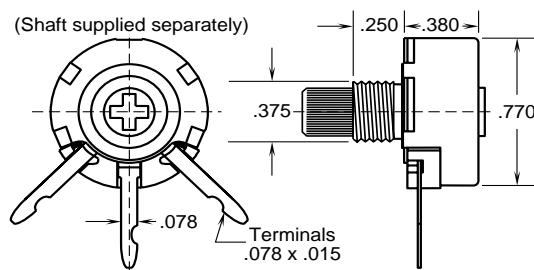

Ohms Rating	Max Amperes	Catalog Number
100	.170	MR100B

Bushing 3/8-32 x 1/4"

DuraCap International Incorporated www.duracap.com

P.O. Box 210, 59 Montclair Drive, Woodstock, Ontario, N4S 7W8, Canada

Telephone: (519) 539-4891

Fax: (519) 539-6684

Bushing Mount Wirewound Controls



3 Watt - R Series

Power Rating: 3 Watts @ 40°C
Derated linearly to 0 @ 105°C
Ohms Tolerance: ± 10% (Standard)
(Other tolerances available)
Dielectric Strength: Mounting plate to terminals,
high pot test for 1 minute
@ 900 VAC
Insulation Resistance: 1000 megohms minimum
(50% relative humidity @ 25°C)

Operating Temperature: -30°C to +105°C
Operating Life: 10,000 cycles standard
Resistance Taper: Linear
(Other tapers available)
Mechanical Rotation: 297° ± 5°
Bushing Information: Thread: 3/8-32 NEF-2A
Contact Arm: Insulated from case

Ohms Rating	Max. Amperes	Catalog Number
10	.548	R10L
500	.077	R500L
1K	.055	R1000L
2.5K	.035	R2500L

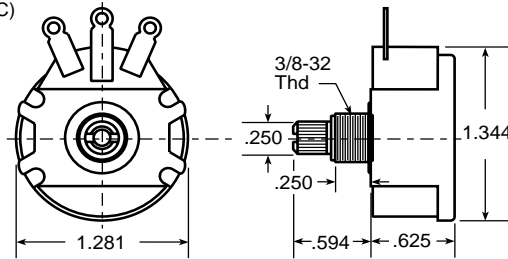

4 Watt - M Series

Power Rating: 4 Watts @ 40°C
Ohms Tolerance: ± 10% (Standard)
(Other tolerances available)
Dielectric Strength: Mounting plate to terminals,
high pot test for 1 minute
@ 900 VAC
Insulation Resistance: 1000 megohms minimum
(50% relative humidity @ 25°C)

Operating Temperature: -55°C to +105°C
Operating Life: 10,000 cycles standard
Resistance Taper: Linear
(Other tapers available)
Mechanical Rotation: 294° ± 5°
Bushing Information: Thread: 3/8-32 NEF-2A
Contact Arm: Insulated from case

Ohms Rating	Max. Amperes	Catalog Number
1	2.000	M1PK
3	1.150	M3PK
6	.816	M6PK
15	.516	M15PK
25	.400	M25PK
50	.280	M50PK
100	.200	M100PK
200	.140	M200PK
300	.116	M300PK
500	.090	M500PK
1K	.063	M1MPK
2K	.045	M2MPK
5K	.028	M5MPK
10K	.020	M10MPK
20K	.014	M20MPK
25K	.013	M25MPK
50K	.009	M50MPK
100K	.0062	M100MPK

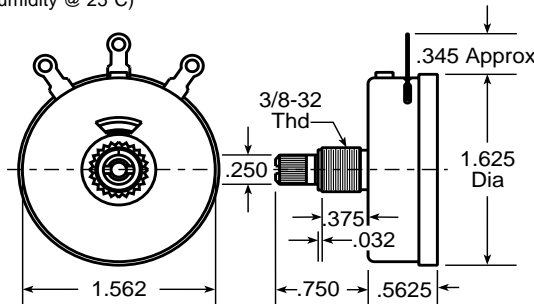

5 Watt - VW Series

Power Rating: 5 Watts @ 35°C
Ohms Tolerance: ± 10% (Standard)
(Other tolerances available)
Dielectric Strength: Mounting plate to terminals,
high pot test for 1 minute
@ 900 VAC
Insulation Resistance: 1000 megohms minimum
(50% relative humidity @ 25°C)

Operating Temperature: -30°C to +105°C
Operating Life: 10,000 cycles standard
Resistance Taper: Linear
(Others available)
Mechanical Rotation: 305° ± 5°
Bushing Information: Thread: 3/8-32 NEF-2A
Contact Arm: Insulated from case

Ohms Rating	Max. Amperes	Catalog Number
1	2.2	VW1
2	1.6	VW2
5	1.0	VW5
8	.750	VW8
10	.710	VW10
15	.580	VW15
20	.500	VW20
25	.450	VW25
50	.320	VW50
100	.220	VW100
200	.160	VW200
250	.140	VW250
300	.130	VW300
500	.100	VW500
1K	.071	VW1K
2K	.050	VW2K
2.5K	.045	VW2P5K
3K	.041	VW3K
4K	.035	VW4K
5K	.032	VW5K
10K	.022	VW10K
20K	.016	VW20K
25K	.014	VW25K

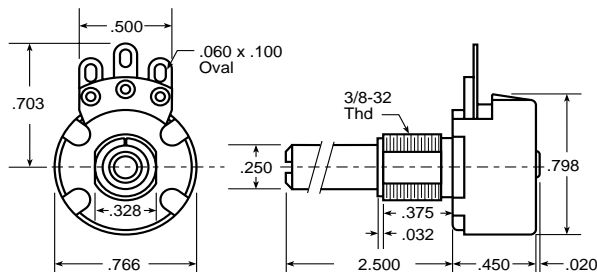

5 Watt - VWS Series

Power Rating: 5 Watts @ 35°C
 Ohms Tolerance: ± 10% (Standard)
 Dielectric Strength: Mounting plate to terminals,
 high pot test for 1 minute
 @ 900 VAC
 Insulation Resistance: 1000 megohms minimum
 (50% relative humidity @ 25°C)

Operating Temperature: -30°C to +105°C
 Operating Life: 10,000 cycles standard
 Resistance Taper: Linear
 Mechanical Rotation: 305° ± 5°
 Bushing Information: Thread: 3/8-32 NEF-2A
 Contact Arm: Insulated from case

Ohms Rating	Max. Amperes	Catalog Number
1	2.200	VWS1
50	.320	VWS50
100	.220	VWS100
200	.160	VWS200
1K	.071	VWS1K
5K	.032	VWS5K
20K	.016	VWS20K

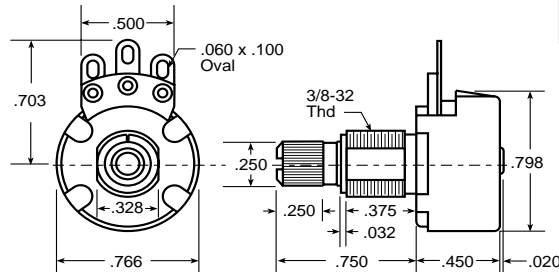

5 Watts - LW Series

Power Rating: 5 Watts @ 25°C
 4 Watts @ 55°C
 Ohms Tolerance: ± 10% (Standard)
 Dielectric Strength: Mounting plate to terminals,
 high pot test for 1 minute
 @ 900 VAC
 Insulation Resistance: 1000 megohms minimum
 (50% relative humidity @ 25°C)

Operating Temperature: -30°C to +105°C
 Operating Life: 10,000 cycles standard
 Resistance Taper: Linear only
 Mechanical Rotation: 300° ± 5°
 Bushing Information: Thread: 3/8-32 NEF-2A
 Contact Arm: Insulated from case

Ohms Rating	Max. Amperes	Catalog Number
5	.890	LW5
8	.710	LW8
10	.630	LW10
25	.450	LW25
50	.280	LW50
100	.200	LW100
250	.130	LW250
500	.089	LW500
1K	.063	LW1K
1.5K	.058	LW1P5K
2.5K	.040	LW2P5K
5K	.028	LW5K
10K	.020	LW10K

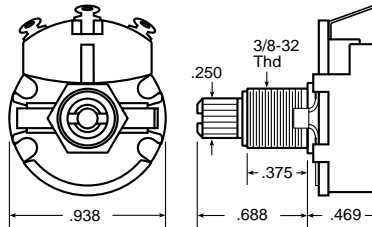

12.5 Watts - MG Series

Power Rating: 12.5 Watts @ 40°C
 Derated linearly to 0°C @ 250°C
 Ohms Tolerance: ± 10% (Standard)
 Dielectric Strength: Mounting plate to terminals,
 high pot test for 1 minute
 @ 900 VAC
 Insulation Resistance: 1000 megohms minimum
 (50% relative humidity @ 25°C)

Operating Temperature: -55°C to +250°C
 Operating Life: 10,000 cycles standard
 Resistance Taper: Linear
 Mechanical Rotation: 294° ± 5°
 Bushing Information: Thread: 3/8-32 NEF-2A
 Contact Arm: Insulated from case

Ohms Rating	Max. Amperes	Catalog Number
10	1.100	MG10
25	.710	MG25
50	.550	MG50
500	.160	MG500
1K	.110	MG1000
2.5K	.070	MG2500
25K	.022	MG25K

